

Service instructions

CR(N) 32, 45, 64 and 90

Model A

50/60 Hz

3~



1.	Type identification	2
1.1	Nameplate CR, CRN	2
1.2	Type key	3
1.3	Codes used.....	3
2.	Tightening torques and lubricants.....	4
3.	Service tools	5
3.1	Special tools	5
3.2	Standard tools.....	6
3.3	Torque tools.....	6
4.	Dismantling and assembly	7
4.1	General information	7
4.2	Replacement of motor	8
4.3	Replacement of motor stool.....	9
4.4	Replacement of coupling	9
4.5	Replacement of shaft seal	10
4.6	Replacement of basic unit	11
4.7	Replacement of chamber stack	12
4.8	Dismantling of chamber stack.....	13
4.9	Assembly of chamber stack.....	15
5.	Order of assembly for chambers and impellers	17
5.1	CR(N) 32.....	17
5.2	CR(N) 45.....	18
5.3	CR(N) 64.....	19
5.4	CR(N) 90.....	20

1. Type identification

This section shows the type key, the nameplate and the codes that can appear in the variant code.

Note: As codes can be combined, a code position may contain more than one code (letter).

1.1 Nameplate CR, CRN

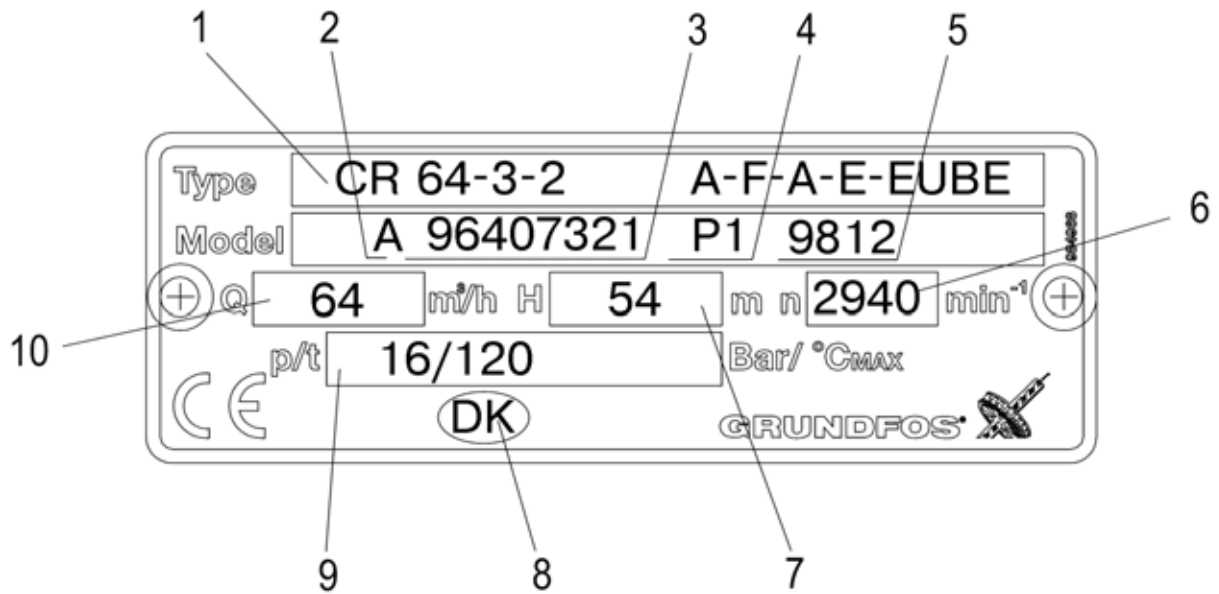

Pos.	Description	Pos.	Description
1	Type designation	6	Speed
2	Model	7	Head at rated flow rate
3	Product number	8	Country of production
4	Place of production	9	Maximum pressure and temperature
5	Production year and week	10	Rated flow rate

TM02 1822 2101

1.2 Type key

Example	CR	64 -	3-	2	X-	X-	X-	X-	XXXX
Type range									
Rated flow rate in m ³ /h									
Number of stages									
Number of reduced-diameter impellers									
Code for pump version a)									
Code for pipe connection b)									
Code for pump materials c)									
Code for rubber components in pump d)									
Code for shaft seal e)									

1.3 Codes used

Note	Code	Description
a	A	Basic version
	U	NEMA version
	F	DIN flange
b	G	ANSI flange
	J	JIS flange
	A	Basic version
c	G	Stainless steel parts in DIN W.-Nr. 1.4401 / AISI 316
	GI	Base plate and flanges in DIN W.-Nr. 1.4408 / AISI 316LN
d	E	EPDM
	V	FKM
e	EUBE/V	Cartridge seal with O-ring; rotating face: tungsten carbide; stationary seat: resin-impregnated carbon; O-rings: E=EPDM, V=FKM
	EUHE/V	Cartridge seal with O-ring; rotating face: tungsten carbide; stationary seat: embedded tungsten carbide; O-rings: E=EPDM, V=FKM
	EUUE/V	Cartridge seal with O-ring; rotating face: tungsten carbide; stationary seat: tungsten carbide; O-rings: E=EPDM, V=FKM
	HUBE/V	Balanced cartridge seal; rotating face: tungsten carbide; stationary seat: resin-impregnated carbon; O-rings: E=EPDM, V=FKM

2. Tightening torques and lubricants

Pos.	Description	Dim.	Torque [Nm]	Lubricant
9	Hexagon socket head screw	M10 x 25	85	THREAD-EZE
18	Air vent screw		5/20	Gardolube L 6034
23	Plug	1/2"	35	THREAD-EZE
25				
26b	Hexagon socket head screw	M8 x 30	15	Gardolube L 6034
28	Hexagon socket head screw	M10 x 50	62	THREAD-EZE
28a	Hexagon head screw	M8 x 20	12	THREAD-EZE
		M12 x 40	40	
		M16 x 50	80	
	Hexagon socket head screw	1/2" x 13 UNC	40	
		5/8" x 11 UNC	80	
31	Hexagon socket head screw	M6 x 10	8	Gardolube L 6034
36	Nut	M16	100	THREAD-EZE
36a	Nut	M12	40	THREAD-EZE
		M16	80	
48	Split cone nut	M30 x 1	70	Gardolube L 6034
58a	Hexagon socket head screw	M10 x 25	62	THREAD-EZE
67	Hexagon socket head screw	M8 x 16	31	Gardolube L 6034

THREAD-EZE, part no. SV9997 (0,5 l).

Gardolube L 6034, part no. SV9995 (1 l).

3. Service tools

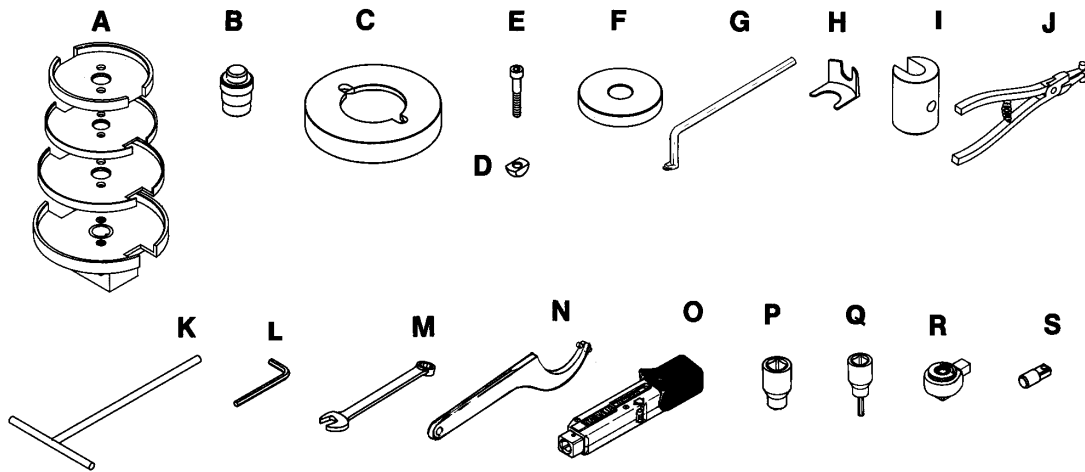

TM00 2158 1398

3.1 Special tools

Pos.	Description	For pos.	Suppl. information	Part no.
A	Holder with pin for dismantling and assembly		CR(N) 32 ~ SV0003-3	SV0003
			CR(N) 45 ~ SV0003-4	
			CR(N) 64 ~ SV0003-5	
			CR(N) 90 ~ SV0003-2	
B	Punch	6g-47-47c-47d-47e		SV0015
C	Holder for wear ring	49c	CR(N) 32	SV0043
			CR(N) 45	SV0044
			CR(N) 64	SV0045
			CR(N) 90	SV0046
D	Puller for bottom bearing	6g		SV0002
E	Hexagon socket head screw for puller		M8 x 50	ID6595
F	Punch for fitting of neck ring/retainer	45a-65	CR(N) 32	SV0025
			CR(N) 45	SV0027
			CR(N) 64	SV0028
			CR(N) 90	SV0029
G	Puller for wear ring	49c		SV0239
H	Forked distance piece	105		985924
I	Key for split cone nut	48-S	34 mm	SV0004
J	Pliers for retaining ring	203		SV0047

3.2 Standard tools

Pos.	Description	For pos.	Suppl. information	Part no.	
K	Tee key	105 (113)	M6	3 mm	SV0153
		31	M6 -	5 mm	SV0124
		26b-67	M8 -	6 mm	SV0050
		9-58a	M10 -	8 mm	SV0051
L	Hexagon socket head screw key	28-58a	M10 - 8 mm		ID1205
		28a	5/8" - 1/2"		SV0095
		28a	1/2" - 3/8"		SV0096
M	Ring/open-end spanner	28a	M8 - 13 mm		SV0055
		28a-36a	M12 - 19 mm		SV0054
		28a-36-36a	M16 - 24 mm		SV0122
		23-25	1/2" - 24 mm		
N	Hook spanner (adjustable)	49-49a			SV0031

3.3 Torque tools

Pos.	Description	For pos.	Suppl. information	Part no.	
O	Torque wrench	R	4-20 Nm	9 x 12	SV0292
			20-100 Nm	9 x 12	SV0269
P	Socket spanner	28a	M8 - 13 mm	1/2" x 1/2"	SV0091
		28a-36	M12 - 19 mm	1/2" x 1/2"	SV0267
		28a-36-36a	M16 - 24 mm	1/2" x 1/2"	SV0092
		23-25	1/2" - 24 mm	1/2" x 1/2"	
Q	Socket driver for hexagon socket head screws	31	M6 - 5 mm	1/2" x 1/2"	SV0296
		26b-67-E	M8 - 6 mm	1/2" x 1/2"	SV0297
		9-28-58a	M10 - 8 mm	1/2" x 1/2"	SV0298
		28a	1/2" - 3/8"	1/2" x 1/2"	SV0094
			5/8" - 1/2"	1/2" x 1/2"	SV0093
		R	Ratchet insert tool	O-P-Q	9 x 12 -> 1/2" x 1/2"
S	Tap for key for split cone nut	48-l	Ø14	9 x 12	SV0403

4. Dismantling and assembly

4.1 General information

The Grundfos centrifugal pumps, type CR(N) 32, 45, 64 and 90 are multistage in-line pumps.

If the pump is choked or damaged, please follow the instructions below.

Position numbers, see "Parts list" and [3. Service tools](#).

Before dismantling the pump, switch off the electricity supply to the motor and close the isolating valves, if fitted, to avoid draining the system.

The electric cable should be removed in accordance with local regulations.

Before assembly, clean and check all parts. Parts that are defective should be replaced by new parts.

Order the necessary service kits, see "Parts list".

Gaskets and O-rings should always be replaced when the pump is overhauled.

The pump should be tested according to the test specifications below:

	50 Hz	60 Hz
CR(N) 32	96428962	96428971
CR(N) 45	96428972	96428973
CR(N) 64	96428974	96428975
CR(N) 90	96428976	96428977

4.2 Replacement of motor

4.2.1 Dismantling

Slacken the screws, (pos. 7a), and remove them together with the coupling guards, (pos. 7).

Keep the shaft seal in position on the shaft by inserting the distance piece, (pos. H), between the shaft seal, (pos. 105), and the seal carrier, (pos. 58). See fig. 1.

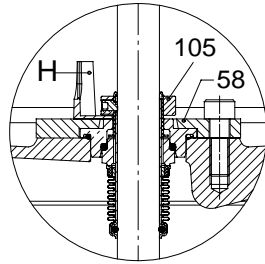

TM01 1927 0698

Fig. 1

Slacken the screws, (pos. 9), and remove them together with the coupling, (pos. 8).

Slacken and remove the screws, (pos. 28a), and the nuts, (pos. 36a).

Carefully lift the motor free of the pump using lifting equipment suitable for the motor size.

4.2.2 Assembly

Before assembly, clean all parts.

Fit the motor and turn it to the required terminal box position.

Lubricate the screws, (pos. 28a), and the nuts, (pos. 36a), with THREAD-EZE. Fit them and tighten diagonally. See 2. [Tightening torques and lubricants](#).

Before fitting the coupling, check that the forked distance piece, (pos. H), is still inserted between the shaft seal, (pos. 105), and the seal carrier, (pos. 58).

Fit the coupling, (pos. 8), on the shaft so that the top of the pump shaft is flush with the bottom of the clearance chamber in the coupling. See fig. 2.

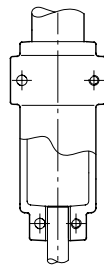

TM01 1930 0698

Fig. 2

Lubricate the hexagon socket head screws, (pos. 9). Fit the screws, tighten and leave loose.

Check that the gaps either side of the coupling halves are equal.

Tighten the hexagon socket head screws, (pos. 9), two and two (one side at a time). See 2. [Tightening torques and lubricants](#).

Pull the forked distance piece, (pos. H), free of the shaft, turn it and store it on the screw, (pos. 58a).

Fit the coupling guards, (pos. 7), and fasten them with the screws, (pos. 7a).

4.3 Replacement of motor stool

4.3.1 Dismantling

Slacken the screws, (pos. 7a), and remove them together with the coupling guards, (pos. 7).

Keep the shaft seal in position on the shaft by inserting the distance piece, (pos. H), between the shaft seal, (pos. 105), and the seal carrier, (pos. 58). See fig. 1.

Slacken the screws, (pos. 9), and remove them together with the coupling, (pos. 8).

Slacken and remove the screws, (pos. 28a), and the nuts, (pos. 36a).

Carefully lift the motor free of the pump using lifting equipment suitable for the motor size.

Slacken the screws, (pos. 28), and remove them together with the motor stool, (pos. 1a).

4.3.2 Assembly

Before assembly, clean all parts.

Fit the motor stool, (pos. 1a), and turn it to the required position.

Lubricate the screws, (pos. 28). Fit the screws and tighten diagonally. See [2. Tightening torques and lubricants](#).

Fit the motor and turn it to the required terminal box position.

Lubricate the screws, (pos. 28a), and nuts, (pos. 36a). Fit them and tighten diagonally. See [2. Tightening torques and lubricants](#).

Before fitting the coupling, check that the forked distance piece, (pos. H), is still inserted between the shaft seal, (pos. 105), and the seal carrier, (pos. 58).

Fit the coupling, (pos. 8), on the shaft so that the top of the pump shaft is flush with the bottom of the clearance chamber in the coupling. See fig. 2.

Lubricate the hexagon socket head screws, (pos. 9). Fit the screws, tighten and leave loose.

Check that the gaps either side of the coupling halves are equal.

Tighten the hexagon socket head screws, (pos. 9), two and two (one side at a time). See [2. Tightening torques and lubricants](#).

Pull the forked distance piece, (pos. H), free of the shaft, turn it and store it on the screw, (pos. 58a).

Fit the coupling guards, (pos. 7), and fasten them with the screws, (pos. 7a).

4.4 Replacement of coupling

4.4.1 Dismantling

Slacken the screws, (pos. 7a), and remove them together with the coupling guards, (pos. 7).

Keep the shaft seal in position on the shaft by inserting the distance piece, (pos. H), between the shaft seal, (pos. 105), and the seal carrier, (pos. 58). See fig. 1.

Slacken the screws, (pos. 9), and remove them together with the coupling, (pos. 8).

4.4.2 Assembly

Before assembly, clean all parts.

Before fitting the coupling, check that the forked distance piece, (pos. H), is still inserted between the shaft seal, (pos. 105), and the seal carrier, (pos. 58).

Fit the coupling, (pos. 8), on the shaft so that the top of the pump shaft is flush with the bottom of the clearance chamber in the coupling. See fig. 2.

Lubricate the hexagon socket head screws, (pos. 9). Fit the screws, tighten and leave loose.

Check that the gaps either side of the coupling halves are equal.

Tighten the hexagon socket head screws, (pos. 9), two and two (one side at a time). See [2. Tightening torques and lubricants](#).

Pull the forked distance piece, (pos. H), free of the shaft, turn it and store it on the screw, (pos. 58a).

Fit the coupling guards, (pos. 7), and fasten them with the screws, (pos. 7a).

4.5 Replacement of shaft seal

4.5.1 Dismantling

To enable replacement of shaft seal, motors up to and including 7.5 kW/10.0 HP must be removed; motors larger than 7.5 kW need not be removed.

Slacken the screws, (pos. 7a), and remove them together with the coupling guards, (pos. 7).

Slacken the screws, (pos. 9), and remove them together with the coupling, (pos. 8).

Pumps with motors up to and including 7,5 kW/10 HP

Slacken and remove the screws, (pos. 28a), and the nuts, (pos. 36a).

Carefully lift the motor free of the pump using lifting equipment suitable for the motor size.

Slacken the screws, (pos. 58a), and remove them together with the seal carrier, (pos. 58).

Clean the shaft end. Slacken the three screws, (pos. 113), so that they do not touch the shaft.

The screws should be slackened only so much that the shaft seal can be removed from the shaft.

Loosen the shaft seal, (pos. 105), from the pump head using two screwdrivers. See fig. 3, and pull it off the shaft.

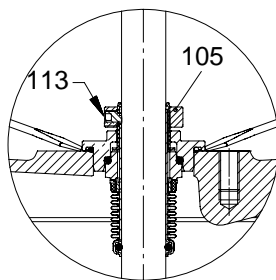

TN01 2027 0998

Fig. 3

4.5.2 Assembly

Clean and smooth the shaft before fitting the shaft seal. Use the holder with emery cloth supplied with the shaft seal kit. Apply O-ring grease to the shaft end and the O-ring of the shaft seal, (pos. 105). Press the shaft seal down on the shaft and against the pump head.

Remove excess grease from the shaft end using a cloth.

Fit the seal carrier, (pos. 58).

Lubricate the screws, (pos. 58a). Fit the screws and tighten diagonally. See [2. Tightening torques and lubricants](#).

Press the pump shaft home and fasten the shaft seal on the shaft with the screws, (pos. 113). See fig. 1.

Lift the pump shaft and insert the forked distance piece, (pos. H), between the shaft seal, (pos. 105), and the seal carrier, (pos. 58). See fig. 1.

Pumps with motors up to and including 7,5 kW/10 HP

Fit the motor and turn it to the required terminal box position.

Lubricate the screws, (pos. 28a), and the nuts, (pos. 36a). Fit them and tighten diagonally to the torque stated. See [2. Tightening torques and lubricants](#).

Fit the coupling, (pos. 8), on the shaft so that the top of the pump shaft is flush with the bottom of the clearance chamber in the coupling. See fig. 2.

Lubricate the hexagon socket head screws, (pos. 9). Fit the screws, tighten and leave loose.

Check that the gaps either side of the coupling halves are equal.

Tighten the hexagon socket head screws, (pos. 9), two and two (one side at a time). See [2. Tightening torques and lubricants](#).

Pull the forked distance piece, (pos. H), free of the shaft, turn it and store it on the screw, (pos. 58a).

Fit the coupling guards, (pos. 7), and fasten them with the screws, (pos. 7a).

4.6 Replacement of basic unit

4.6.1 Dismantling

Slacken the screws, (pos. 7a), and remove them together with the coupling guards, (pos. 7).

Slacken the screws, (pos. 9), and remove them together with the coupling, (pos. 8).

Slacken and remove the screws, (pos. 28).

Carefully lift the motor and the motor stool, (pos. 1a), free of the pump using lifting equipment suitable for the motor size.

Slacken the screws, (pos. 58a), and remove them together with the seal carrier, (pos. 58).

Clean the shaft end. Slacken the three screws, (pos. 113), so that they do not touch the shaft.

The screws should be slackened only so much that the shaft seal can be removed from the shaft.

Loosen the shaft seal, (pos. 105), from the pump head using two screwdrivers. See fig. 3, and pull it off the shaft.

4.6.2 Assembly

Make sure that the shaft end is clean, intact, smooth and without visible scratches.

Apply O-ring grease to the shaft end and the O-ring of the shaft seal, (pos. 105). Press the shaft seal down on the shaft and against the pump head.

Remove excess grease from the shaft end using a cloth.

Fit the seal carrier, (pos. 58).

Lubricate the screws, (pos. 58a). Fit the screws and tighten diagonally. See [2. Tightening torques and lubricants](#).

Press the pump shaft home and fasten the shaft seal on the shaft with the screws, (pos. 113). See fig. 1.

Lift the pump shaft and insert the forked distance piece, (pos. H), between the shaft seal, (pos. 105), and the seal carrier, (pos. 58). See fig. 1.

Fit the motor with motor stool, (pos. 1a), and turn it to the required terminal box position.

Lubricate the screws, (pos. 28). Fit the screws and tighten diagonally. See [2. Tightening torques and lubricants](#).

Before fitting the coupling, check that the forked distance piece, (pos. H), is still inserted between the shaft seal, (pos. 105), and the seal carrier, (pos. 58).

Fit the coupling, (pos. 8), on the shaft so that the top of the pump shaft is flush with the bottom of the clearance chamber in the coupling. See fig. 2.

Lubricate the hexagon socket head screws, (pos. 9). Fit the screws, tighten and leave loose.

Check that the gaps either side of the coupling halves are equal.

Tighten the hexagon socket head screws, (pos. 9), two and two (one side at a time). See [2. Tightening torques and lubricants](#).

Pull the forked distance piece, (pos. H), free of the shaft, turn it and store it on the screw, (pos. 58a).

Fit the coupling guards, (pos. 7), and fasten them with the screws, (pos. 7a).

4.7 Replacement of chamber stack

4.7.1 Dismantling

Remove the basic unit. See [4.6 Replacement of basic unit](#).

Slacken the nuts, (pos. 36), and remove them together with the washers, (pos. 66a).

Knock the pump head, (pos. 2a), free of the outer sleeve, (pos. 55), by means of a rubber mallet.

Remove the pump head and the outer sleeve.

Carefully pull the chamber stack, (pos. 80), up and free of the base complete, (pos. 6b).

Remove the O-rings, (pos. 37).

4.7.2 Assembly

Before assembly, clean all parts.

Apply O-ring grease to new O-rings, (pos. 37), and fit the rings in the base, (pos. 6b), and the pump head, (pos. 2a), respectively. At the same time, replace the four rubber springs, (pos. 60), in the pump head.

Carefully fit the chamber stack into the base, (pos. 6b), and displace the straps 45° in relation to the staybolts.

Fit the outer sleeve, (pos. 55), into the base, (pos. 6b).

Fit the pump head, (pos. 2a), with the air vent screw, (pos. 18), in its previous position.

Fit the washers, (pos. 66a).

Lubricate the nuts, (pos. 36). Fit the nuts and tighten diagonally. See [2. Tightening torques and lubricants](#).

Continue the assembly. See [4.6 Replacement of basic unit](#).

4.8 Dismantling of chamber stack

Place the holder for dismantling and assembly, (pos. A), in a vice and tighten it.

Make sure that the ring fitting the inlet part, (pos. 44), is placed in the holder. See 3. Service tools.

When dismantling the chamber stack, use the holder hole marked "Dismantling". See fig. 4.

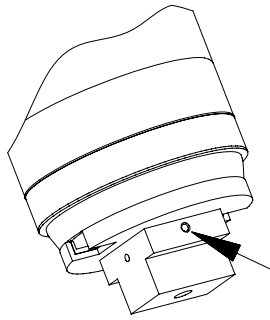

TM01 2050 0998

Fig. 4

Place the chamber stack so that the fixing lugs for straps on the inlet part are above the cutouts in the holder. Make sure that the chamber stack engages with the holder.

Turn the shaft so that the hole in the shaft and the holder hole marked "Dismantling" are in the same position. Fit the pin into the hole to hold the shaft.

Slacken the screws, (pos. 26b), and remove them together with the washers, (pos. 26c), and the straps, (pos. 26a).

Dismantle the chamber stack as follows:

Symbols refer to 5. Order of assembly for chambers and impellers.



Loosen the top chamber, (pos. 3), from the chamber/inlet part using a screwdriver.

Hold the impeller with the hook spanner, (pos. N), and slacken the split cone nut, (pos. 48), by means of the key, (pos. I).

Turn the key and knock the nut to loosen the impeller from the split cone, (pos. 49b).

Pull the split cone nut, (pos. 48), the split cone, (pos. 49b), and the impeller off the shaft.



Loosen the chamber, (pos. 4), from the chamber below or the inlet part using a screwdriver.

Hold the impeller with the hook spanner, (pos. N), and slacken the split cone nut, (pos. 48), by means of the key, (pos. I).

Turn the key and knock the nut to loosen the impeller from the split cone, (pos. 49b).

Pull the split cone nut, (pos. 48), the split cone, (pos. 49b), and the impeller off the shaft.



Loosen the chamber with bearing, (pos. 4a), from the chamber below using a screwdriver.

Loosen the bearing ring with driver, (pos. 47a), from the split cone nut, (pos. 48), using a screwdriver and pull it off the shaft.

Hold the impeller with the hook spanner, (pos. N), and slacken the split cone nut, (pos. 48), by means of the key, (pos. I).

Turn the key and knock the nut to loosen the impeller from the split cone, (pos. 49b).

Pull the split cone nut, (pos. 48), the split cone, (pos. 49b), and the impeller off the shaft.

When the last impeller has been removed, the inlet part can be lifted off the holder.

The chamber stack is now dismantled.

Impeller (pos. 49/49a) and neck ring complete (pos. 45a)

If the tolerance (clearance) between the impeller (wear ring, (pos. 49c)) and the neck ring, (pos. 45), is too big, replace the worn part(s).

Impeller (wear ring (pos. 49c))

If the wear ring is worn or deformed, remove it by pushing it up and free of the impeller using the holder, (pos. C), and the puller, (pos. G). See fig. 5.

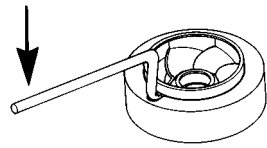

TIM00 7233 0996

Fig. 5

Neck ring (pos. 45)

Push the neck ring retainer, (pos. 65), up and free of the cup using a screwdriver, and remove the neck ring.

Neck ring complete (pos. 45a)

If the neck ring complete is defective, push it up and free of the chamber/inlet part using two screwdrivers, and replace it.

Bearing ring with driver (pos. 47a) and stationary bearing ring (pos. 47)

The maximum permissible difference between the diameters of the bearing rings is 0.3 mm. If the difference is greater, the worn part(s) must be replaced.

Bush (pos. 47c)

The maximum permissible difference between the diameters of the bush and the shaft is 1.0 mm. If the difference is greater, the worn part(s) must be replaced.

Stationary bearing ring (pos. 47), bush (pos. 47c) and retaining rings (pos. 47d and 47e)

Place the chamber on a level and solid surface with the neck ring complete, (pos. 45a), uppermost.

Support the hub in the chamber. *Make sure that the bearing ring, bush and retaining ring can pass freely out of the chamber when they are pressed/knocked out of the chamber.*

Stationary bearing ring (pos. 6g) and rotating bearing ring (pos. 47b)

The maximum permissible difference between the diameters of the stationary and the rotating bottom bearing ring is 0.3 mm. If the difference is greater, the worn part(s) must be replaced.

Stationary bearing ring (pos. 6g)

Slacken the screw, (pos. 31), and remove it together with the washer, (pos. 32).

Place the puller, (pos. D), underneath the bearing ring (pos. 6g).

Screw the hexagon socket head screw, (pos. E), into the puller.

Pull the puller against the bearing ring, and at the same time screw the hexagon socket head screw against the bottom of the base.

Make sure that the hexagon socket head screw is in the centre of the bottom bearing.

Turn the hexagon socket head screw until the bearing ring is free of the base.

Rotating bearing ring (pos. 47b)

Slacken the hexagon socket head screw, (pos. 67), and remove it together with the washers, (pos. 66b and 66).

Pull the bearing ring off the shaft.

4.9 Assembly of chamber stack

Before assembly, clean and check all parts. Parts that are defective or do not comply with the above measurements due to wear should be replaced by new parts.

Impeller (pos. 49 and 49a)

Press the wear ring, (pos. 49c), carefully down over the impeller skirt.

Make sure to push the ring straight down and home against the impeller skirt and take care not to damage the impeller.

Neck ring (pos. 45)

Place the neck ring, (pos. 45), in the cup.

Fit the neck ring retainer, (pos. 65), with the four driving dogs pointing downwards. Turn the neck ring retainer until it engages with the neck ring.

Knock the neck ring retainer against the cup using the punch, (pos. F). See check measurements below.

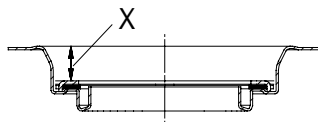

TM01 1955 2201

Fig. 6

Pump	Nominal height X [mm]	Tolerance [mm]
CR(N) 32	10.1	±0.2
CR(N) 45	15.5	
CR(N) 64	11.5	
CR(N) 90	12.1	

It must be possible to move the neck ring freely (sideways) between the neck ring retainer and the cup.

Neck ring complete (pos. 45a)

Fit the neck ring complete and knock/press it home against the chamber/inlet part using the punch, (pos. F).

Stationary bearing ring (pos. 47), bush (pos. 47c) and retaining rings (pos. 47d and 47e)

Place the chamber on a level and solid surface with the neck ring complete, (pos. 45a), face downward.

Support the hub in the chamber. Knock/press the bearing ring/bush and retaining ring home against the chamber using the punch, (pos. B).

Stationary bearing ring (pos. 6g)

Knock/press the bottom bearing into the base (against the shoulder) using the punch, (pos. B).

Rotating bearing ring (pos. 47b)

Fit the bearing ring (pos. 47b) to the shaft.

Fit the washers, (pos. 66 and 66b). Lubricate the hexagon socket head screw, (pos. 67) and tighten it. See [2. Tightening torques and lubricants](#).

Chamber stack (pos. 80)

Place the holder for dismantling and assembly, (pos. A), in a vice and tighten it.

Make sure that the ring fitting the inlet part, (pos. 44), is placed in the holder.

When assembling the chamber stack, use the holder hole marked "Assembly". See fig. 7.

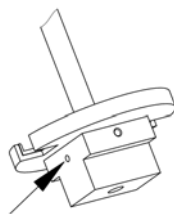

TM01 2028 0998

Fig. 7

Place the shaft in the holder.

Turn the shaft so that the hole in the shaft and the holder hole marked "Assembly" are in the same position. Fit the pin into the hole to hold the shaft.

Fit the inlet part, (pos. 44), with neck ring complete, (pos. 45a), and turn it so that the fixing lugs for straps on the inlet part are above the cutouts in the holder. Make sure that the inlet part engages with the holder.

Continue the assembly as follows:

Symbols refer to [5. Order of assembly for chambers and impellers](#).



Fit the impeller and the split cone, (pos. 49b).

Press the impeller home, and knock the split cone into the impeller hub using the key, (pos. I).

Hold the impeller with the hook spanner, (pos. N), and fit and tighten the split cone nut, (pos. 48). See [2. Tightening torques and lubricants](#).

Fit the top chamber, (pos. 3), and turn it so that the holes for straps are aligned to the fixing lugs for straps on the inlet part.

Press the top chamber home against the chamber below or the inlet part.



Fit the impeller and the split cone, (pos. 49b).

Press the impeller home, and knock the split cone into the impeller hub using the key, (pos. I).

Hold the impeller with the hook spanner, (pos. N), and fit and tighten the split cone nut, (pos. 48). See [2. Tightening torques and lubricants](#).

Fit the chamber, (pos. 4), and press it home against the chamber below or the inlet part.



Fit the impeller and the split cone, (pos. 49b).

Press the impeller home, and knock the split cone into the impeller hub using the key, (pos. I).

Hold the impeller with the hook spanner, (pos. N), and fit and tighten the split cone nut, (pos. 48). See [2. Tightening torques and lubricants](#).

Slide the bearing ring with driver, (pos. 47a), over the split cone nut. It must engage with the split cone nut.

Fit the chamber with bearing, (pos. 4a), and press it home against the chamber below.

Fit the straps, (pos. 26a), the washers, (pos. 26c), and the screws, (pos. 26b). Lubricate the screws and tighten. See [2. Tightening torques and lubricants](#).

Remove the pin holding the shaft, and lift the chamber stack off the holder.

Check the impeller position. See [fig. 8](#).

Further assembly. See [4.7.2 Assembly](#).

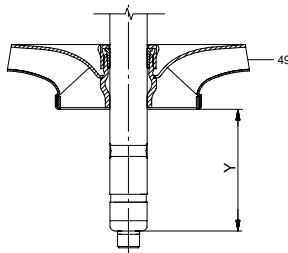

TM01 2467 2201

Fig. 8

Pump	Nominal height Y [mm]
CR(N) 32	70
CR(N) 45	71
CR(N) 64	70
CR(N) 90	78

5. Order of assembly for chambers and impellers

5.1 CR(N) 32

The assembly of the pump is illustrated in the table by symbols.

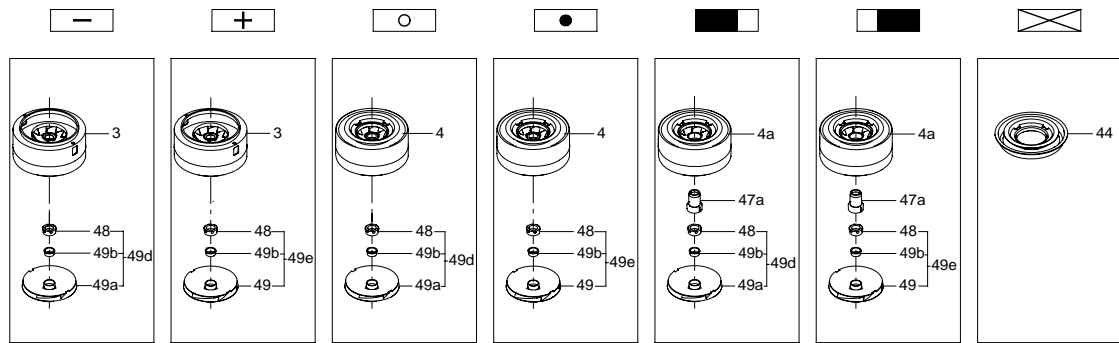
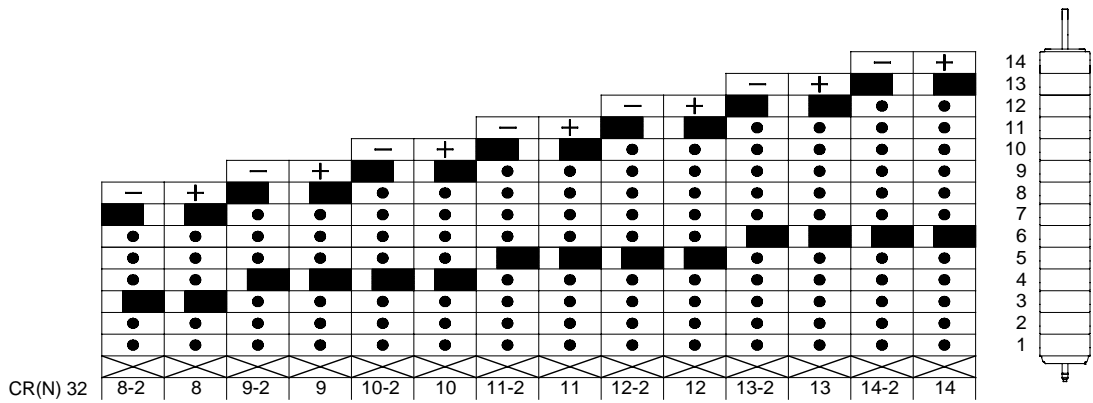
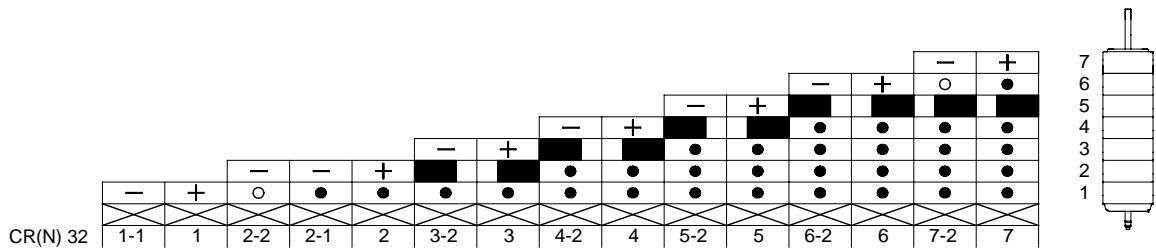

TM01 1855 1000

5.2 CR(N) 45

The assembly of the pump is illustrated in the table by symbols

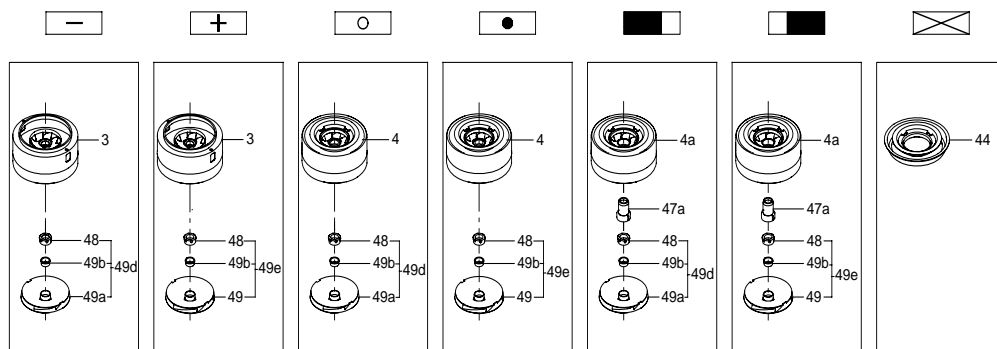
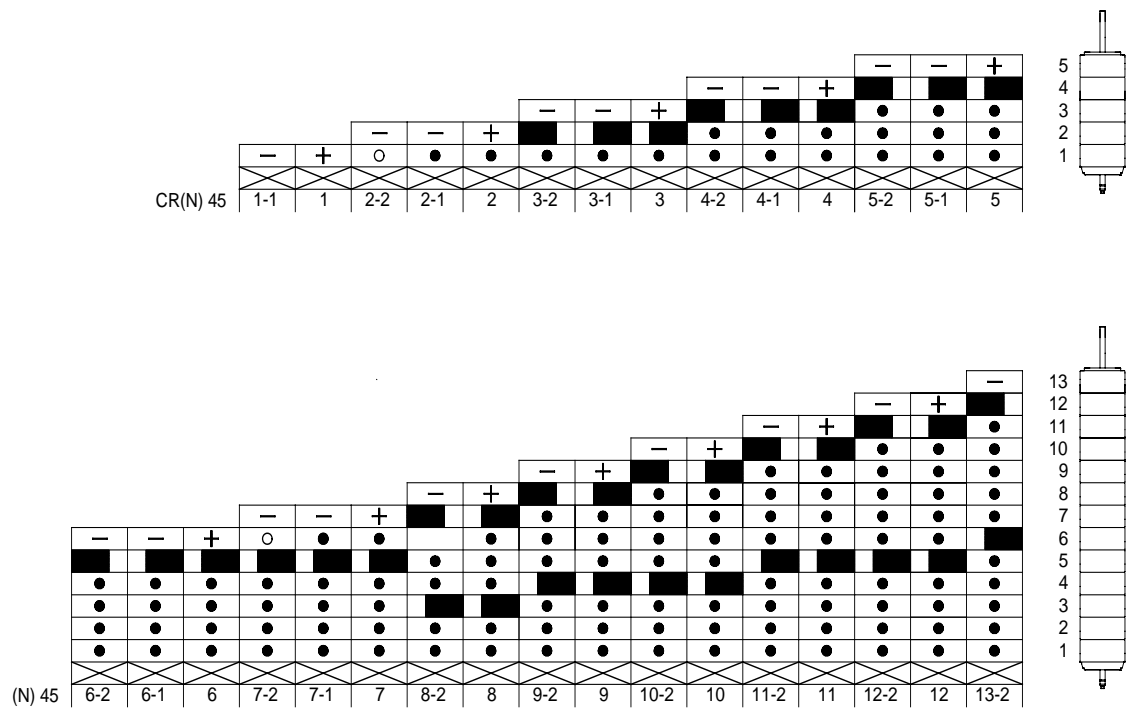

TM01 1856 3701

5.3 CR(N) 64

The assembly of the pump is illustrated in the table by symbols

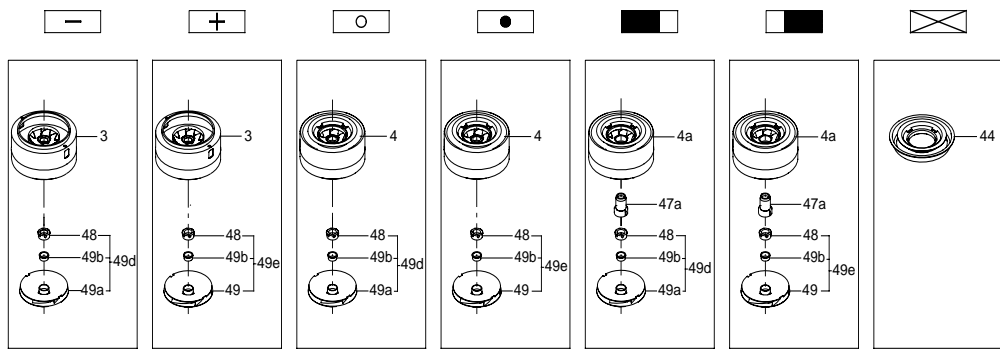
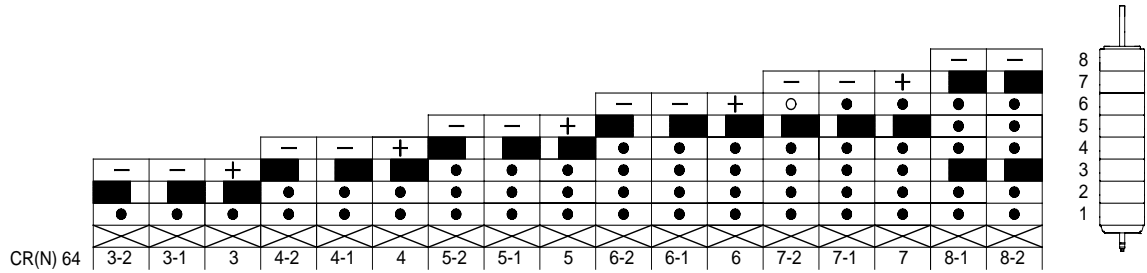
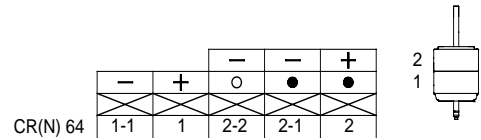

TM01 1857 37010

5.4 CR(N) 90

The assembly of the pump is illustrated in the table by symbols

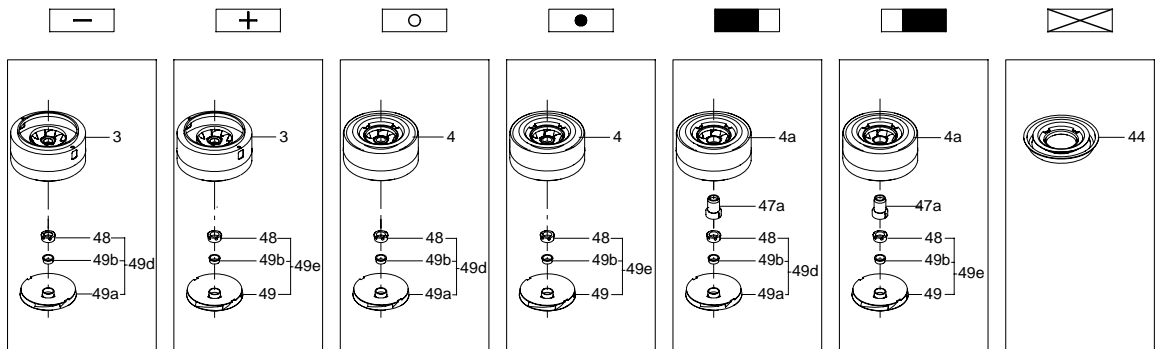
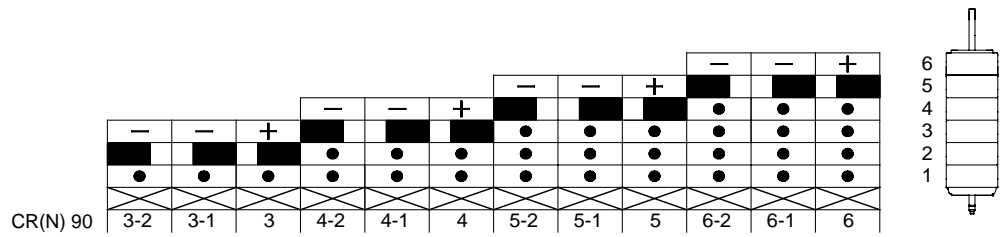
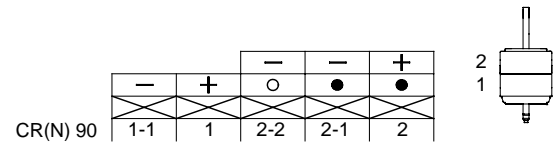

TN01 1858 2201